

Koala

infant bed



User Manual

MD

Infant bed

UDI

111737169210

Effective date: May 2021
Issue Number: 01 Verson 02 EN
Issue Date: May 2021

www.mtts-asia.com

Contents

Company Information	04
Introduction	05
Device Description	06
Warnings	07
Setting up Warmer	10
Cleaning	12
Maintenance	14
Specifications	16
Explanation of Symbols	18
Warranty Policy	19

Company Information





MEDICAL TECHNOLOGY TRANSFER AND SERVICES Co., LTD
House No. 26, Alley 41, An Duong Vuong Street, Tay Ho District, Hanoi City, Vietnam

Tel: +84 24 3766 6521
Fax: +84 24 3718 8050
Email: assistance@mtts-asia.com
www.mtts-asia.com

Logic s.r.l.
Via Antonio Pigafetta 1
34147 Trieste, Italy



Introduction

-  WARNING - a warning statement refers to the conditions when the possibility of injury to the patient or user exists if a procedure is not followed correctly.
-  NOTE - a note statement provides additional information intended to clarify points, procedures or instructions.

 This user manual is intended for health care professionals.

The Koala infant bed has a simple hand-crank system designed on the principle of driving power and swingarm, quite flexible to help change easily.

The four wheels can be rotated 360 degrees and locked to easily move and brake when needed

The crib edges of the bed are made of transparent Mica material and angled to help easily observe the patient inside and avoid injury to the patient.

Device Description

Overview

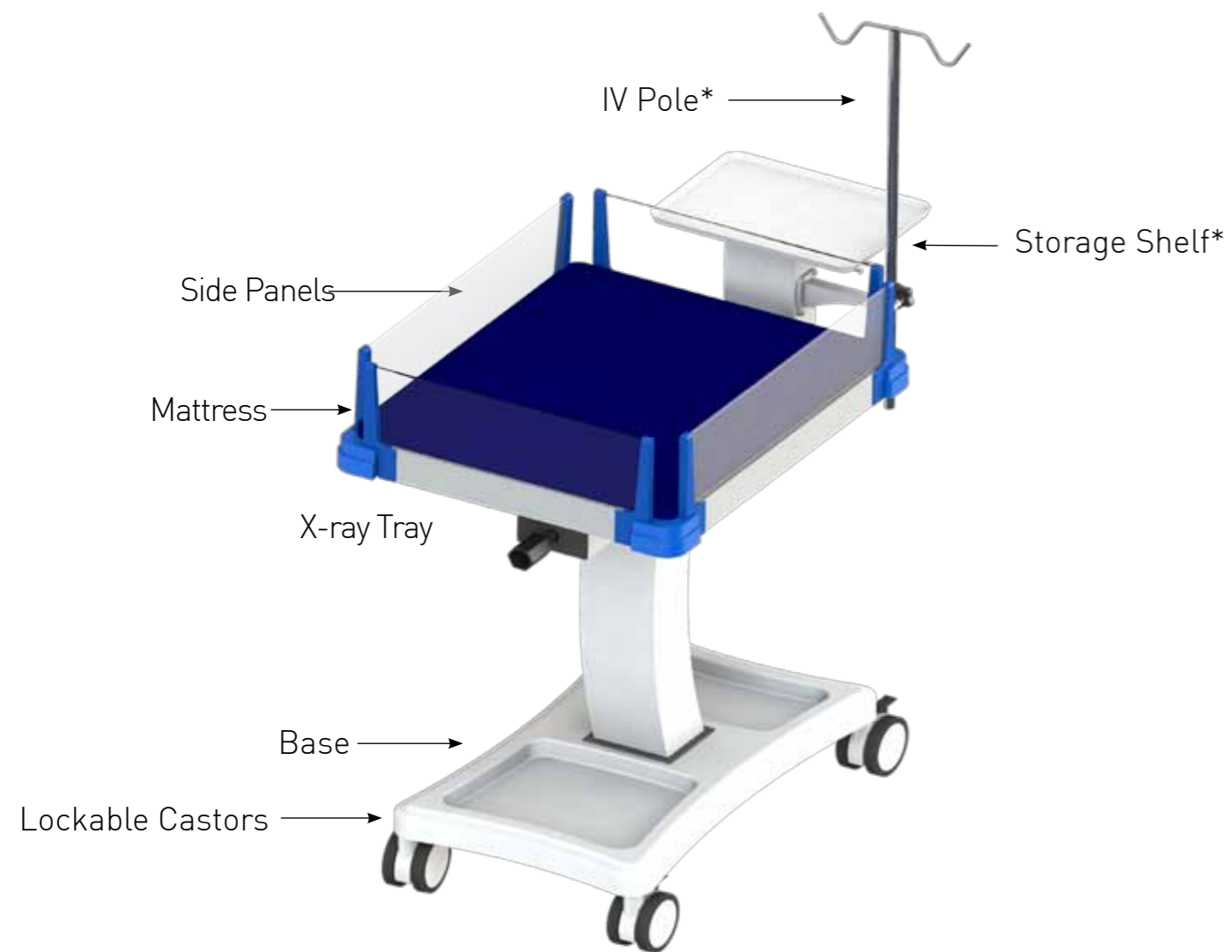

* Optional accessories









Warnings

User and Patient Safety

- ⚠ Using the device outside of the specified ambient temperature range (10-40°C) or humidity range (30-90%RH) can compromise performance.
- ⚠ Do not operate the device if any of the components appear to be damaged or broken. Damaged or broken components should be discarded and replaced.
- ⚠ Do not modify this equipment without authorization of the manufacturer.
- ⚠ Overloading the shelves may affect the stability of the bed.
- ⚠ Lock the front wheels before changing the angle of the bed.



Warnings

Device

-  Ensure the bed is level and side panels are locked into position before transport.
-  Do not move the bed by pushing or pulling on the bed side panels. This action may lead to the deterioration and breakage of the components that act as a safety barrier around the baby.
-  Inspect all the tubes and wires connected to the baby before and after tilting the bed. Tilting or moving the warmer bed can pull on tubing or leads.
-  Do not use the bed without the mattress.
-  Ensure the patient and operator limbs are clear of bed side panels when opening and closing.
-  Do not leave the baby unattended in the bed when the side panels are folded down.
-  Do not lean on the bed.
-  Take care not to dislodge tubes and lines when opening or closing side panels.
-  Regularly check side panels are securely locked in the vertical position.

Warnings

Bed Loadings

-  Maximum bed loading is 10kg.
-  Do not exceed maximum total storage shelf of 5kg.

Cleaning and Maintenance

-  Only qualified personnel should carry out service and maintenance procedures.

Setting up Bed

STEP 1 - Remove components from the box

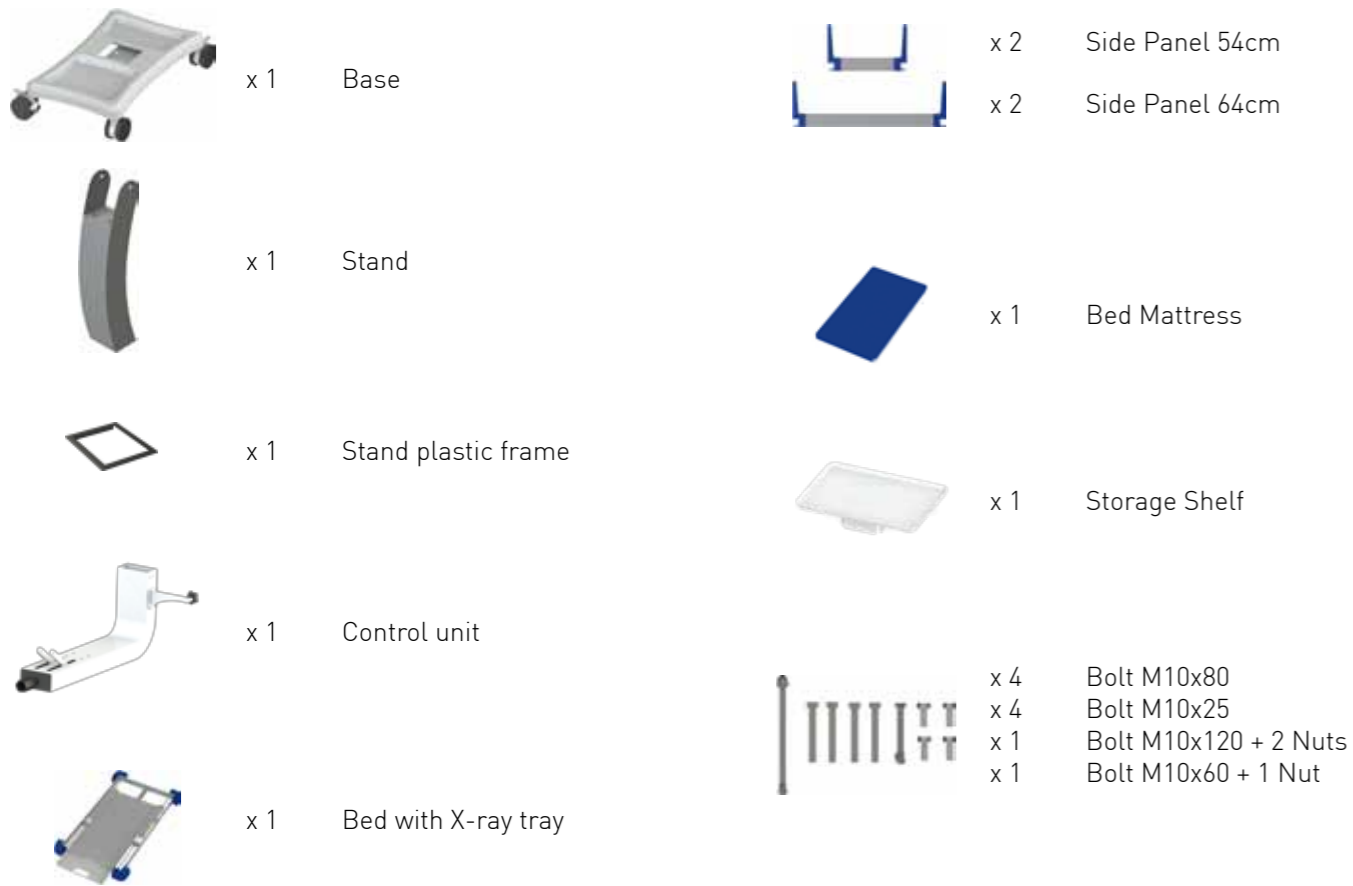

STEP 2 - Attach Stand to Base

 Two people might be required to perform this step

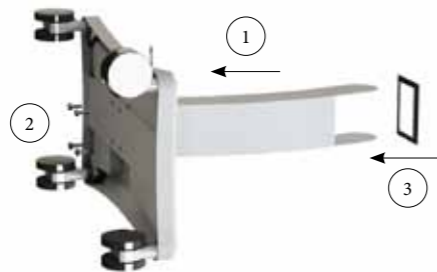

Setting up Bed

STEP 3 - Attach Control Unit to and Hand Crank to Stand

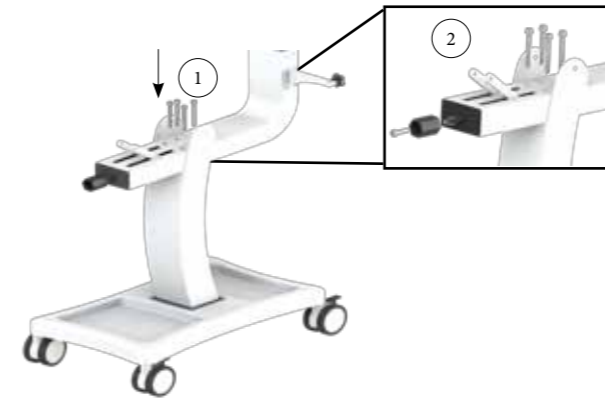

STEP 4 - Attach storage shelves

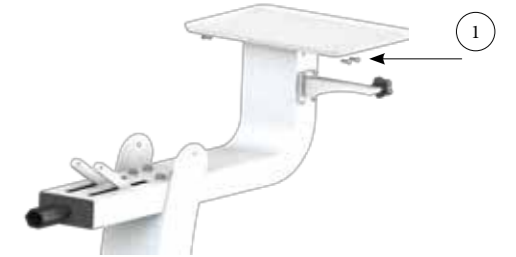

STEP 5 - Attach Side Panel to Bed

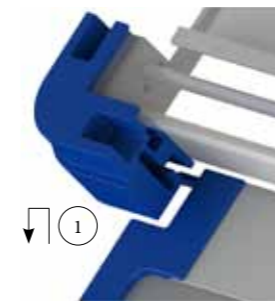

STEP 6 - Attach Bed

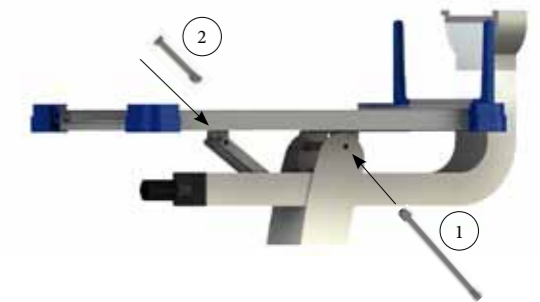

 Attach only side panel that is closest to the Control Unit in this step. Remaining panels will be attached in STEP 7.



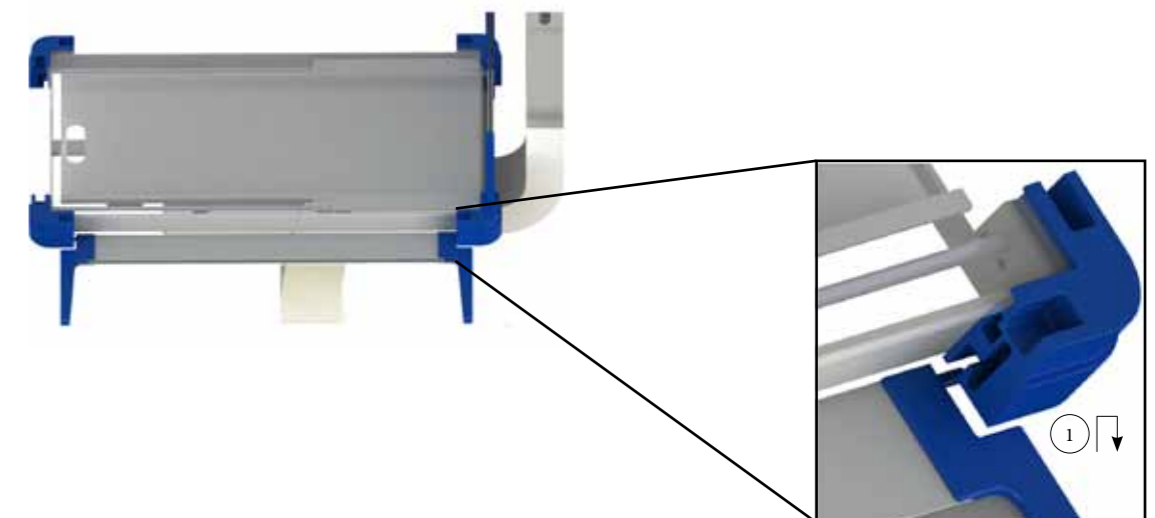





STEP 7 - Attach 3 remaining Side Panels to Bed



Cleaning

General

Clean Koala Infant Bed and accessories either weekly or between patients using the following cleaning procedures:

-  Comply with hospital, local and national guidelines for product cleaning frequencies.
-  Cleaning shall be performed at ambient conditions. Allow heated surfaces to cool for at least one hour or cool to the touch before cleaning.
-  Before cleaning, remove and discard all used disposable products using recommended method of disposal.
-  Dust all surfaces with clean damp soft cloth.
-  Clean all plastic surfaces with detergent based solution (maximum 2% in water) ensuring the manufacturer's directions for use of the cleaning agent are followed.
-  Dry all the surfaces after cleaning with a clean soft cloth or paper towel.
-  Ensure that no part of the device or related accessories is immersed in any cleaning liquid or cleaning solution.
-  Do not use abrasive cleaning solutions.
-  Ensure all Koala Infant Bed parts and accessories are checked before returning the device to service.

Cleaning



Mattress

1. Clean the mattress with an approved and correctly diluted disinfectant-detergent solution, ensuring the manufacturer's directions for use of the cleaning agent are followed.
2. Apply the cleaning solution with clean cloth or sponge, and dry all surfaces after cleaning with a clean soft cloth or paper towel.

-  Do not autoclave the mattress.

Maintenance

 Only qualified personnel should carry out service and maintenance procedures.

-  After the maintenance is completed, ensure the equipment is functioning correctly in accordance with the published performance specifications.
-  Ensure only approved replacement parts are used during service and maintenance procedures.
-  Please contact an authorised MTTs representative for further assistance with any servicing or maintenance requirement.

Bed and X-ray tray

Bed should be checked annually to ensure reliable operation. The following procedure should be used by your technician:

1. Check each bed side panel for smooth operation and correct latching. Replace if defective.
2. Check X-ray tray module for smooth operation and correct placement of X-ray cassette. Replace if defective.
3. Check the operation of the tilt mechanism for smooth movement and that appropriate resistance can be felt.
4. Check that M6x120 bolt, which the bed pivots on is not loosened. Tighten if necessary.

Maintenance

Base

The base should be checked at least annually to ensure reliable operation. The following procedure should be used by your technician:

1. Check all base fittings are secure.
2. Check castors rotate freely and castor brakes operate correctly.

Specifications

Physical Specifications

Dimensions (LxWxD)		94.5 cm x 55 cm x 110cm
Total unit mass		44 kg
Shipping weight		55 kg
Maximum load		20 kg
Mattress	Material	Waterproof PU
	Foam Denisty	22kg/m ³
	Size	54 x 64 x 3 cm
Bed tilting positions		-12° to +12°
Castors		4 x 100mm, all locking
Monitor / Storage tray		30 x 20 cm
X-ray cassette	Size	26 x 70 cm
	Thickness	1 mm

Specifications

Environmental Specifications

Operating	Ambient temperature 10°C to 40°C Humidity: 30% to 90% RH non condensing Atmospheric Pressure: 70-106kPa
Transport and storage	Ambient temperature 0°C to +50°C Humidity: 5% to 90% RH non condensing Atmospheric Pressure: 70-106kPa
Exclusions	None

Explanation of Symbols



This statement provides important information or highlights information that may be easily overlooked.



This statement is a warning. Not following this statement could result in injury to the patient or operator, or damage to the device.



CE Marking



Do not disassemble the device unless you are an MTTs trained technician or have been instructed to by qualified personnel.



Refer to the user manual before operating this device.



Refer to the user manual before operating this device.



This device should be disposed of separately from normal household waste so that components can be recycled.



Medical device



Unique identification number



Website where a user can obtain additional information on the medical product



Name and address of European Authorized Representative.



Device manufacturer.



Date of manufacture.



Serial number.



Maximum load.



Keep out of direct sunlight.



Liquid ingress protection - level 0 (no protection against water).

Warranty Policy

General Terms

This MTTs Limited Warranty gives you, the customer, express limited warranty rights from MTTs, the manufacturer for the duration specified on the Warranty Card. Please refer to the MTTs Website for an extensive description of your limited warranty entitlements. In addition, you may also have other legal rights under applicable law or special written agreement with MTTs.

MTTS MAKES NO OTHER EXPRESS WARRANTY OR CONDITION WHETHER WRITTEN OR ORAL AND MTTS EXPRESSLY DISCLAIMS ALL WARRANTIES AND CONDITIONS NOT STATED IN THIS LIMITED WARRANTY. TO THE EXTENT ALLOWED BY LOCAL LAW OF JURISDICTIONS OUTSIDE VIETNAM, MTTS DISCLAIMS ALL IMPLIED WARRANTIES OR CONDITIONS, INCLUDING ANY IMPLIED WARRANTIES OF MERCHANTABILITY AND FITNESS FOR A PARTICULAR PURPOSE. FOR ALL TRANSACTIONS OCCURRING IN VIETNAM ANY IMPLIED WARRANTY OR CONDITION OF MERCHANTABILITY, SATISFACTORY QUALITY, OR FITNESS FOR A PARTICULAR PURPOSE IS LIMITED TO THE DURATION OF THE EXPRESS WARRANTY SET FORTH ABOVE. SOME COUNTRIES DO NOT ALLOW A LIMITATION ON HOW LONG AN IMPLIED WARRANTY LASTS OR THE EXCLUSION OR LIMITATION OF INCIDENTAL OR CONSEQUENTIAL DAMAGES FOR CONSUMER PRODUCTS. IN SUCH COUNTRIES, SOME EXCLUSIONS OR LIMITATIONS OF THIS LIMITED WARRANTY MAY NOT APPLY TO YOU. FOR CONSUMER TRANSACTION, THE LIMITED WARRANTY TERMS CONTAINED IN THIS STATEMENT, EXCEPT TO THE EXTENT LAWFULLY PERMITTED, DO NOT EXCLUDE, RESTRICT, OR MODIFY BUT ARE IN ADDITION TO THE MANDATORY STATUTORY RIGHTS APPLICABLE TO THE SALE OF THIS PRODUCT TO YOU.

This Limited Warranty is applicable in all countries and may be enforced in any country or region where MTTs or its authorized service providers offer warranty service for the same product model number (subject to the terms and conditions set forth in this Limited Warranty)

Under this Limited Warranty, products purchased in one country or region may be transferred to another country or region where MTTs or its authorized service providers offer warranty service for the same product model number. Warranty terms, service availability, and service response times may vary from country or region to country or region. Standard warranty service response time is subject to change due to local parts availability. If so, your MTTs authorized service provider can provide you with details. MTTs will not alter form, fit, or function of this MTTs product to make it operate in a country for which it was never intended to function for legal or regulatory reasons. MTTs is not responsible for any tariffs or duties that may be incurred in transferring the products.

MTTS guarantees that the product that you have purchased or leased from MTTs is free from defects in materials or workmanship under normal use during Limited Warranty Period. The Limited Warranty Period starts on the date of purchase or lease from MTTs, or from the date MTTs completes installation. Your dated sales or delivery receipt, showing the date of purchase of the product, is your proof of the purchase or lease date. You may be required to provide proof of purchase or lease as a condition of receiving warranty service. You are entitled to hardware warranty service according to the terms and conditions of this document if a repair to your MTTs product is required within the Limited Warranty Period.

Unless otherwise stated, and to the extent permitted by local law, new MTTs product may be manufactured using new materials and used materials equivalent to new in performance and reliability. MTTs may repair or replace MTTs products (a) with new or previously used products or parts equivalent to new in performance and reliability, or (b) with equivalent products to an original product that has been discontinued. Replacement parts are warranted to be free from defects in material or workmanship for ninety (90) days or, for the remainder of Limited Warranty Period of the MTTs product they are replacing or in which they are installed, whichever is longer.

Warranty Policy

MTTS will, at its sole discretion, repair or replace any components or product that manifests a defect in materials or workmanship during the Limited Warranty Period. All component parts removed under this Limited Warranty become the property of MTTS. In the unlikely event that your MTTS product has recurring failures, MTTS at its sole discretion, may elect to provide you with (a) a replacement unit selected by MTTS that is the same or equivalent to your MTTS product in performance or (b) to give you a refund of your purchase price or lease payments (less interests) instead of a replacement. This is your exclusive remedy for defective products.

Exclusions

MTTS DOES NOT WARRANT THAT THE OPERATION OF THIS PRODUCT WILL BE UNINTERRUPTED OR ERROR-FREE. MTTS IS NOT RESPONSIBLE FOR DAMAGE THAT OCCURS AS RESULT OF YOUR FAILURE TO FOLLOW THE INSTRUCTIONS INTENDED FOR THE PRODUCT.

This Limited Warranty does not apply to expendable or consumable parts and does not extend to any product from which the serial number has been removed or that has been damaged or rendered defective (a) as a result of accident, misuse, abuse, contamination, improper or inadequate maintenance or calibration (if required) or other external causes; (b) by operation outside the usage parameters stated in the user documentation shipped with the product; (c) by software, interfacing, parts or supplies not supplied by MTTS; (d) improper site preparation or maintenance; (e) virus infection; (f) loss or damage in transit; or (g) by modification or service by anyone other than (i) MTTS personnel, (ii) an MTTS authorized service provider, or (iii) your own installation of end-user replaceable MTTS or MTTS approved parts if available for your MTTS product in the servicing country or region.

Limitation of Liability

IF YOUR MTTS PRODUCT FAILS TO WORK AS WARRANTED ABOVE, THE MAXIMUM LIABILITY OF MTTS UNDER THIS LIMITED WARRANTY IS EXPRESSLY LIMITED TO THE LESSER OF THE PRICE YOU HAVE PAID FOR THE PRODUCT OR THE COSTS OF REPAIR OR REPLACEMENT OF ANY HARDWARE COMPONENTS THAT MALFUNCTION IN CONDITIONS OF NORMAL USE.

EXCEPT AS INDICATED ABOVE, IN NO EVENT WILL MTTS BE LIABLE FOR ANY DAMAGES CAUSED BY THE PRODUCT OR THE FAILURE OF THE PRODUCT TO PERFORM, INCLUDING ANY LOST PROFITS OR SAVINGS OR SPECIAL, INCIDENTAL, OR CONSEQUENTIAL DAMAGES. MTTS IS NOT LIABLE FOR ANY CLAIM MADE BY A THIRD PARTY OR MADE BY YOU FOR A THIRD PARTY.

THIS LIMITATION OF LIABILITY APPLIES WHETHER DAMAGES ARE SOUGHT, OR CLAIM MADE, UNDER THIS LIMITED WARRANTY OR AS A TORT CLAIM (INCLUDING NEGLIGENCE AND STRICT PRODUCT LIABILITY), A CONTRACT CLAIM, OR ANY OTHER CLAIM. THIS LIMITATION LIABILITY CANNOT BE WAIVED OR AMENDED BY ANY PERSON. THIS LIMITATION OF LIABILITY WILL BE EFFECTIVE EVEN IF YOU HAVE ADVISED MTTS OF THE POSSIBILITY OF ANY SUCH DAMAGES. THIS LIMITATION OF LIABILITY, HOWEVER, WILL NOT APPLY TO CLAIMS FOR PERSONAL INJURY.

THIS LIMITED WARRANTY GIVES YOU SPECIFIC LEGAL RIGHTS. YOU MAY ALSO HAVE OTHER RIGHTS THAT MAY VARY FROM COUNTRY TO COUNTRY. YOU ARE ADVISED TO CONSULT APPLICABLE COUNTRY LAWS FOR A FULL DETERMINATION OF YOUR RIGHTS.

Warranty Policy

Limited Warranty Period

The Limited Warranty Period for this MTTS product is a specified, fixed period commencing on the date of purchase and specified on the Warranty Card. The date on your sales receipt is the date of purchase unless MTTS or your reseller informs you otherwise in writing.

Customer Responsibilities

In order to avoid the risk of charges for issues not covered by your limited warranty (issues that are not due to defects in materials and workmanship on MTTS product), you will be asked to assist MTTS as follows:

- Verify configurations, load most recent firmware, install software patches, run MTTS diagnostics and utilities;
- Implement temporary procedures or workarounds provided by MTTS while MTTS works on permanent solution;
- Cooperate with MTTS in attempting to resolve the problem using online chat, email, or telephone. This may involve performing routine diagnostic procedures, installing additional software updates or patches;
- Perform additional tasks as defined within each type of warranty service provided by MTTS and any other actions that MTTS may reasonably request in order to best perform the warranty support

CUSTOMER IS RESPONSIBLE FOR DELIVERING THE PRODUCT (AND ALL COSTS INVOLVED) FROM HIS LOCATION TO THE MTTS AUTHORIZED SERVICE POINT.

Contacting MTTS

If your MTTS product fails during the Limited Warranty Period and the suggestions in the product documentation do not solve the problem, you can receive support by doing one of the following:

- Locate and contact your nearest MTTS service provider via MTTS website:
<http://www.mtts-asia.com/support/>
- Call the Technical Support Centre:
+84 43 766 6521

Before calling MTTS or an MTTS authorized service provider please have the following information available:

- Product serial number and model name
- Applicable error messages
- Detailed questions



MEDICAL TECHNOLOGY TRANSFER AND SERVICES Co., LTD
House No. 26, Alley 41, An Duong Vuong Street, Tay Ho District, Hanoi City, Vietnam

Tel: +84 24 3766 6521
Fax: +84 24 3718 8050
Email: assistance@mtts-asia.com
www.mtts-asia.com



EC REP

Logic s.r.l.
Via Antonio Pigafetta 1
34147 Trieste, Italy

A large, stylized blue logo for MTTS, with the letters "M", "T", and "S" each composed of multiple parallel horizontal lines.