

Colibri

phototherapy



User Manual

MD Infant Phototherapy for Jaundice Treatment

Colibri - V1

UDI 111720640961

Effective date: November 2022
Issue Number: 01 Version: 09 EN
Issue Date: November 2022

www.mtts-asia.com

CE 2265

Contents

Company Information	04
Introduction	05
Device Description	06
Warnings	08
Setting up Phototherapy	09
Using Phototherapy	12
Battery backup (optional)	15
Safety information	17
Cleaning and disinfection	19
Irradiance measurement	20
Specifications	21
Explanation of Symbols	23
Warranty Policy	24

Company Information



MEDICAL TECHNOLOGY TRANSFER AND SERVICES Co., LTD
House No. 26, Alley 41, An Duong Vuong Street, Tay Ho District, Hanoi City, Vietnam

Tel: +84 24 3766 6521
Fax: +84 24 3718 8050
Email: assistance@mtts-asia.com
www.mtts-asia.com

Logic s.r.l.
Via Antonio Pigafetta 1
34147 Trieste, Italy



Introduction

Phototherapy is one of the simplest and safest methods to treat jaundice in neonatal intensive care. Untreated jaundice leads to an excessive level of bilirubin in the blood which may potentially result in brain damage or death.

What does phototherapy do?

Reduces the bilirubin level in the blood through:

Photo-oxidation
Configurational isomerisation
Structural isomerisation

Phototherapy starts medical treatment immediately after it's turned on. It emits very little heat because of the LED light source, so does not cause dehydration.

Phototherapy with Colibri

Colibri Phototherapy equips you to deliver high-intensity phototherapy to treat this potentially hazardous condition.

Device Description

Overview



Device Description

Control Panel

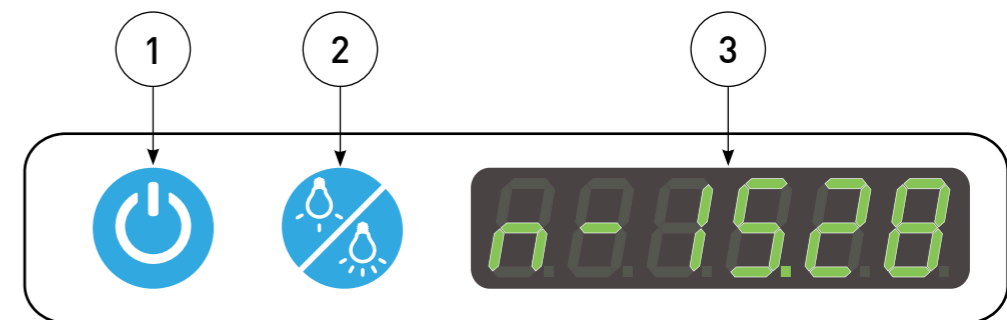

1	On/Off Button	Press this button to turn Colibri Phototherapy display and functions on and off.
2	Therapy Mode Button	Press this button to switch between standard and intensive therapy mode.
3	Display	Shows therapy mode and treatment time.

Warnings

- ⚠ Using the device outside of the specified ambient temperature range (10-35°C) or humidity range (0-90%RH) can compromise performance.
- ⚠ Do not operate the device if any of the components appear to be damaged or broken. Damaged or broken components should be discarded and replaced.
- ⚠ Do not position the device in a location that impairs its ventilation.
- ⚠ Do not cover the device with blankets during operation.
- ⚠ The presence of electro-surgical devices, shortwave or microwave equipment near this device could lead to electrical interference that negatively affects the function of the device.
- ⚠ Do not modify this equipment without authorization of the manufacturer.
- ⚠ **LED lifetime warning:** The blue LEDs in Colibri Phototherapy are rated to provide effective treatment for 60,000 hours.



If the Colibri Phototherapy has been used for over 60,000 hours, after turning ON the display will show the “total device hours” for 3 seconds and ‘Error 4’ message after that. The error message will continue to appear every second during treatment.



Note: The estimated 60,000 hour life span is equal to a full 7 years of non-stop use. After this period of time the LED phototherapy lights will continue to function, however treatment will be significantly less effective and Colibri Phototherapy should be replaced.

Setting up Phototherapy

Step 1 - Remove components from the box

Box contains:

1. Stand
2. Base
3. Canopy set



Step 2 - Stand assembly preparation

1. Remove protection label.
- 2-3. Unscrew slowly height adjustment knob.

⚠ While unscrewing the knob secure inner pole with hand in order to prevent uncontrolled releasing.

4. Remove height adjustment knob.



Setting up Phototherapy

Step 3 - Base assembly

1. Insert the stand into the base.
2. Screw in 3 bolts into the thread hole.
- 3-4. Connect and secure DC connector.
5. Tighten the bolts using wrench (size 13).

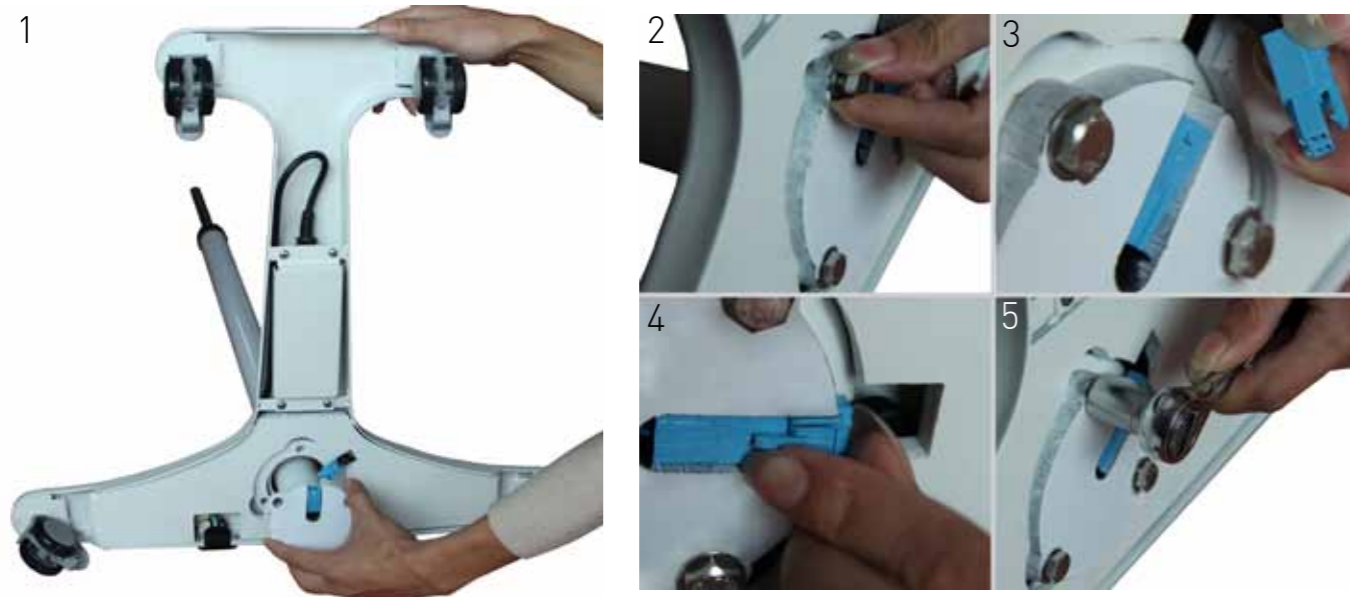

Step 4 - Stand assembly

1. Insert stand support ring.
2. Screw in height adjustment knob.

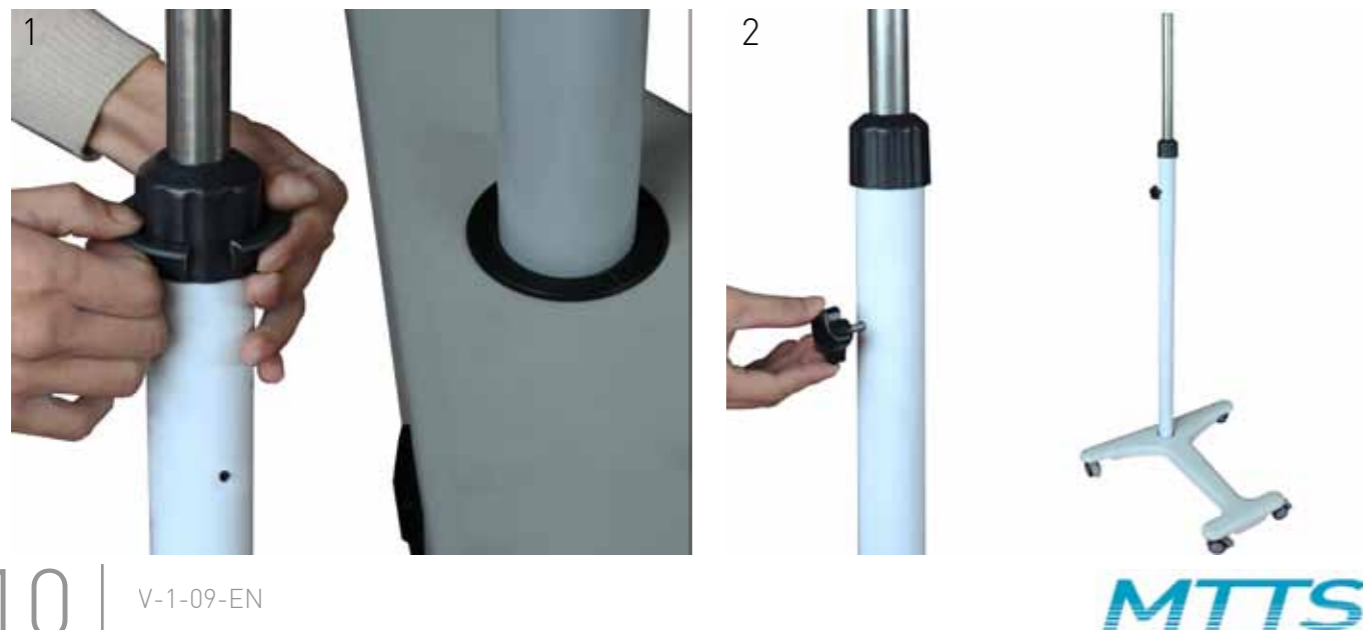

Setting up Phototherapy

Step 5 - Canopy set assembly



1. Pull out plastic bracket with DC connector from inside of the stand.
2. Connect it with the canopy set wire.
- 3-4. Insert connected wire back into the stand and cover it with the plastic bracket.
5. Attach canopy set to the stand and secure it with screws.

 2 people may be required to perform operations 2-4.



Step 6 - Plug in and power up

The connector plugs into the back of the Colibri Phototherapy base and then directly into the power outlet in the wall.

-  Only use power cords and connectors provided by MTTs.
-  Colibri Phototherapy should only be used with the power outlets that have a protective earth (ground) pin.

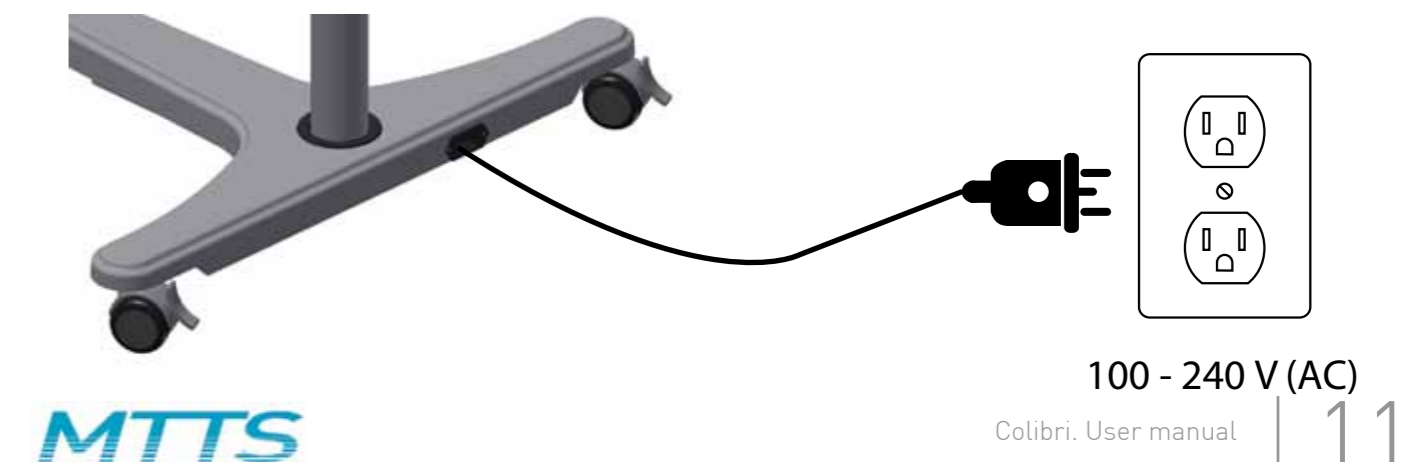

Using Phototherapy

Starting and stopping the therapy

1. Plug in Colibri Phototherapy to the power outlet. Turn on the device by pressing the "On/Off Button".



The display shows the "total device hours". This will be displayed for 3 seconds.

2. The blue phototherapy lights will now start to shine in STANDARD MODE.

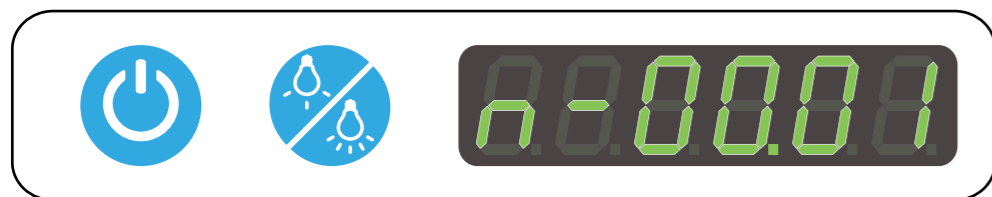

The display will start counting the "treatment time" in STANDARD MODE. This example shows 1 minute of STANDARD therapy.

3. The phototherapy treatment will continue until the doctor decides therapy is no longer necessary and the device can be switched off by pressing "On/Off Button".



This example shows 72 hours 30 minutes of STANDARD therapy.



This example shows the OFF message.

Using Phototherapy

Selecting therapy mode

Colibri Phototherapy can be operated in 2 modes:

- STANDARD: $\sim 33 \mu\text{W}/\text{cm}^2/\text{nm}$
- INTENSIVE: $\sim 57 \mu\text{W}/\text{cm}^2/\text{nm}$

1. To select the mode press the "Therapy Mode Button"
Colibri Phototherapy starts with STANDARD MODE once it is turned on. Pressing the "Therapy Mode Button" will switch it to INTENSIVE MODE.
STANDARD MODE is indicated by the letter "n" on the display ("n" for "normal")
INTENSIVE MODE is indicated by the letter "b" on the display ("b" for "boost")



The display shows the "total device hours of INTENSIVE MODE". This will be displayed for 3 seconds.

2. The blue phototherapy lights will now start to shine in INTENSIVE MODE.



The display will start counting the "treatment time" in INTENSIVE MODE. This example shows 1 minute of INTENSIVE therapy.

3. The phototherapy treatment will continue until the doctor decides therapy is no longer necessary and the device can be switched off by pressing the "On/Off Button".
Pressing the "Therapy Mode Button" will switch back the device to STANDARD MODE and restart the treatment counter.



This example shows 13 hours 20 minutes of INTENSIVE therapy.

-  If there is a power interruption, when the power is restored the device will return to the mode it was in before the interruption of power occurred.

Using Phototherapy

Height adjustment

Colibri Phototherapy can be moved up and down in order to select preferred distance from the light source to the patient. The height of the device is between 115 and 140 cm.

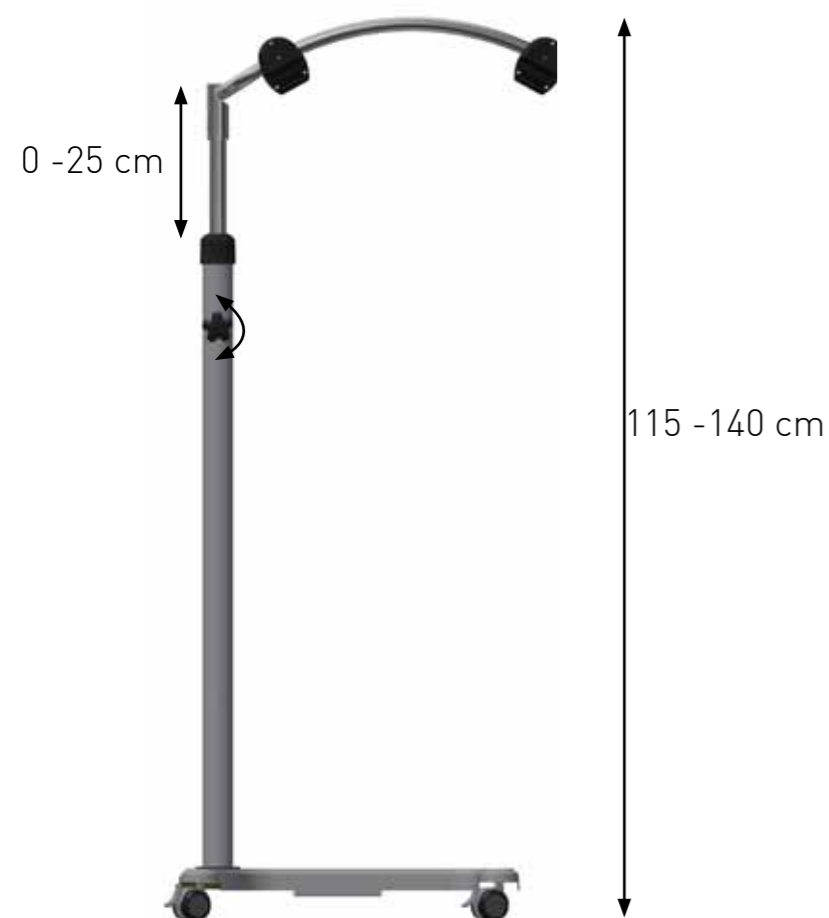

 Recommended distance from the light source to the patient is 30-40 cm.

 Exercise caution when adjusting the height of the Colibri Phototherapy.

Battery backup (optional)

















Battery Backup

The battery backup allows operating the device without AC power supply:

- 3 hours in STANDARD MODE
- 2 hours in INTENSIVE MODE

The backup activates automatically as soon as the AC power supply is off.

To check the battery charge level and obtain additional information, follow the steps below:

Action	Button	Display	Information
Press			Device turned on in STANDARD MODE 1 min of treatment time (see p.12)
Hold 3 seconds			Software version number
Press			Remaining battery capacity percentage
Press			Cell 1 voltage
Press			Cell 2 voltage
Press			Cell 3 voltage
Press			Cell 4 voltage
Press			Device in STANDARD MODE 2 min of treatment time











Battery backup (optional)

Low battery alarm













When the lowest cell voltage reaches 3V, the device informs about low batteries. "Lo bAt" and audible alarm lasts 10 seconds after which the device turns off by itself.

Safety Information



-  Exercise caution when positioning the Colibri Phototherapy around the infant bed.
-  Always lock the caster wheels of the Colibri Phototherapy before starting the treatment.
-  In the event of a power outage, eye coverings should be left on the patient whenever they are under Colibri Phototherapy to protect the patient's eyes in case the power returns.
-  Always cover the patient's eyes with a shield or patch whenever the patient's eyes can be exposed to Colibri Phototherapy light. Periodically, you may want to ensure that the patient's eyes are protected and infection free.
-  Patient's bilirubin values should be measured regularly while undergoing phototherapy treatment.
-  To accurately assess the patient's skin colour, turn off the light when checking the patient's condition.
-  Regularly monitor the patient's temperature and fluid status.
-  Colibri Phototherapy should be disposed of separately from normal household waste so that components can be recycled.
-  DO NOT disassemble any part of the Colibri Phototherapy. None of the parts of the device are designated to be repaired or replaced by service personnel. In case of any problems, contact the nearest MTTs representative.
-  DO NOT use non-standard power cords with Colibri Phototherapy. Using non-standard power cords can result in damaging the device.
-  DO NOT place Colibri Phototherapy in direct sunlight.

Safety Information

-  Colibri Phototherapy should be used only by appropriately trained personnel and under the direction of qualified medical personnel familiar with currently known risks and benefits of infant phototherapy equipment use.
-  Patients adjacent to the Colibri Phototherapy may need to be protected with protective shields or eye protection.
-  The operator may experience some effects during prolonged exposure to the area irradiated by the Colibri Phototherapy.*
-  Blue light can hinder clinical observations by masking skin colour changes, such as cyanosis.
-  An infant's water balance may be influenced by phototherapy. Regular feeding times may need to occur more often in order to prevent dehydration.
-  Varying the ambient conditions (ambient temperature and/or different radiation sources) may negatively affect the patient. Refer to your hospital phototherapy policy and procedure regarding appropriate ambient conditions.
-  Bilirubin photoisomers may be toxic.
-  Do not use Colibri Phototherapy if it appears that any part of the device is not functioning properly or if any parts appear damaged. Contact MTTs.
-  In case of any malfunction DO NOT attempt to service this machine. Colibri Phototherapy should only be serviced by a qualified MTTs technician.
-  Due to photo effects, drugs and infusion liquids should not be stored in the radiation area.
-  Do not use the in the presence of potentially combustible gases including oxygen, nitrous oxide or other anaesthetics.

*Sensitive individuals may experience headache, nausea or mild vertigo if he/she stays too long in the illuminated area. Using Colibri Phototherapy in a well-lighted area or wearing glasses with yellow lenses can alleviate potential effects. Guard Dog Bones glasses (p/n 413BB) are recommended and are available online at www.safetyglasses.com.

Cleaning and disinfection

-  If visibly soiled, clean the affected parts with soap and water using a soft cloth. Then wipe with a wet cloth and dry with a soft cloth. For difficult areas use a standard soft-bristled brush.
-  To loosen heavy, dried-on soil, you may first need to saturate the spot with water.
-  When cleaning the device disconnect the power cord.

Irradiance measurement

Note: To ensure that the device is functioning properly, regularly monitor Colibri Phototherapy in the following way.

Measurement instructions:

To test the irradiance of Colibri Phototherapy, measure using a light meter specifically designed to measure wavelengths for phototherapy.

A stabilization time of 2 hours of continuous operation is required for accurate measuring of the irradiance.

When measuring the irradiance, prop up the light meter 30-40 cm from the top of the canopies to achieve the irradiance seen in the pictures below. Measure the irradiance of Colibri Phototherapy in each of the sections seen in the pictures below.

The lights will decay gradually over time, reaching approximately 70% of their original irradiance after the Colibri Phototherapy device has been used for 60,000 hours. After 60,000 hours of use, the light source will start to degrade rapidly. It is recommended that the device be replaced after 60,000 hours of use. If you must keep using the device after 60,000 hours of use, you should increase the frequency at which you measure the irradiance of the device.

STANDARD MODE

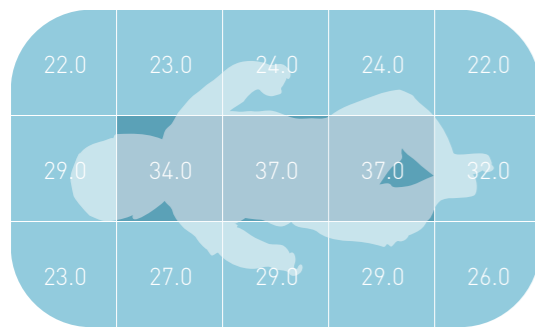

INTENSIVE MODE

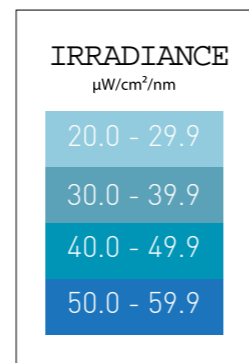
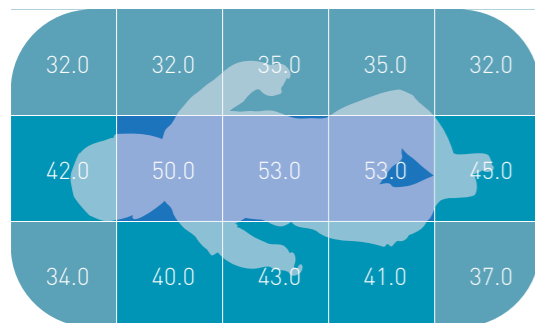

Specifications

Performance Specifications

Illumination source	High-power blue LEDs, 1-1.25W standard operating	
Peak wavelength	445 - 465 nm (peak 455 nm)	
Lamp duration	60,000 hours	
Average spectral irradiance	Standard Mode	28.0 μW/cm ² /nm
	Intensive Mode	40.6 μW/cm ² /nm
Effective surface area	50 cm x 30 cm	
Irradiance Uniformity Ratio	Standard Mode	0.59 (IEC Compliant >0.4)
	Intensive Mode	0.60 (IEC Compliant >0.4)
Time Totalizer	Treatment time, total device hours, total device hours in Intensive Mode	
Measured with	MTTS LM-800 at 40cm	

Physical Specifications

Key features	No moving parts Enclosed designed toward NEMA Type 5	
Dimensions (LxWxD)	max height	60 cm x 55 cm x 155 cm
Height of light source	maximum	140 cm
	minimum	115 cm
Total unit mass	16 kg	

Electrical Specifications

Power characteristics	60W, 100-240VAC, 47/63Hz	
Off-the-shelf internal power supply	Part No. Sinpro MPU60A-105 International medical safety approvals (ANSI/AAMI/EN 60601-1, UL/TUV) Class I construction is standard (ground required) 100k hours MTBF Energy Star Efficiency Level V compliant RoHS 3 compliant Over voltage / over current protection Continuous service	

Power Cords	North America	(part 50-07302-01)
	C.E.	(part 50-07305-01)
	U.K.	(part 50-09273-01)

Specifications

Environmental Specifications

Operating	Ambient temperature +10°C to +35°C Humidity: 0% to 90% RH non condensing Atmospheric Pressure: 70-106kPa
Transport and storage	Ambient temperature 0°C to +50°C Humidity: 0% to 90% RH non condensing Atmospheric Pressure: 70-106kPa
Exclusions	None

Standards for Reference

EN ISO 13485:2016
EN ISO 14971:2012
EN ISO 15223-1:2016
EN1041:2008
EN 60601-1:2006 / A1:2013
EN 60601-1-2:2015
EN 60601-1-6:2010
IEC 60601-2-50:2009
MEDDEV 2.12-1 Rev. 8
ISO 2244:2000
MEDDEV. 2.7.1 Rev.4
MEDDEV. 2.12-2 Rev.2
ROHS 2015/863/EU
WEEE 2012/19/EU

Explanation of Symbols



This statement provides important information or highlights information that may be easily overlooked.



This statement is a warning. Not following this statement could result in injury to the patient or operator, or damage to the device.



CE Marking with Notified Body Number.



Do not disassemble the device unless you are an MTTs trained technician or have been instructed to by qualified personnel (excluding the removal of the bassinet).



Refer to the user manual before operating this device.



Refer to the user manual before operating this device.



This device contains electronic parts. Do not dispose of it with normal waste. Dispose of it according to local guidelines for disposal of electronics. Dispose according to the WEEE directive in the European Union.



Medical device



Unique identification number



Website where a user can obtain additional information on the medical product

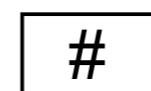

Model number



Catalogue number



Name and address of European Authorized Representative.



Device manufacturer.



Date of manufacture.



Serial number.



An eye patch should always be placed on the patient before commencing treatment.



Keep out of direct sunlight.



Liquid ingress protection - level 1 (dripping water).



Country of manufacture

Warranty Policy

General Terms

This MTTs Limited Warranty gives you, the customer, express limited warranty rights from MTTs, the manufacturer for the duration specified on the Warranty Card. Please refer to the MTTs Website for an extensive description of your limited warranty entitlements. In addition, you may also have other legal rights under applicable law or special written agreement with MTTs.

MTTS MAKES NO OTHER EXPRESS WARRANTY OR CONDITION WHETHER WRITTEN OR ORAL AND MTTS EXPRESSLY DISCLAIMS ALL WARRANTIES AND CONDITIONS NOT STATED IN THIS LIMITED WARRANTY. TO THE EXTENT ALLOWED BY LOCAL LAW OF JURISDICTIONS OUTSIDE VIETNAM, MTTS DISCLAIMS ALL IMPLIED WARRANTIES OR CONDITIONS, INCLUDING ANY IMPLIED WARRANTIES OF MERCHANTABILITY AND FITNESS FOR A PARTICULAR PURPOSE. FOR ALL TRANSACTIONS OCCURRING IN VIETNAM ANY IMPLIED WARRANTY OR CONDITION OF MERCHANTABILITY, SATISFACTORY QUALITY, OR FITNESS FOR A PARTICULAR PURPOSE IS LIMITED TO THE DURATION OF THE EXPRESS WARRANTY SET FORTH ABOVE. SOME COUNTRIES DO NOT ALLOW A LIMITATION ON HOW LONG AN IMPLIED WARRANTY LASTS OR THE EXCLUSION OR LIMITATION OF INCIDENTAL OR CONSEQUENTIAL DAMAGES FOR CONSUMER PRODUCTS. IN SUCH COUNTRIES, SOME EXCLUSIONS OR LIMITATIONS OF THIS LIMITED WARRANTY MAY NOT APPLY TO YOU. FOR CONSUMER TRANSACTION, THE LIMITED WARRANTY TERMS CONTAINED IN THIS STATEMENT, EXCEPT TO THE EXTENT LAWFULLY PERMITTED, DO NOT EXCLUDE, RESTRICT, OR MODIFY BUT ARE IN ADDITION TO THE MANDATORY STATUTORY RIGHTS APPLICABLE TO THE SALE OF THIS PRODUCT TO YOU.

This Limited Warranty is applicable in all countries and may be enforced in any country or region where MTTs or its authorized service providers offer warranty service for the same product model number (subject to the terms and conditions set forth in this Limited Warranty)

Under this Limited Warranty, products purchased in one country or region may be transferred to another country or region where MTTs or its authorized service providers offer warranty service for the same product model number. Warranty terms, service availability, and service response times may vary from country or region to country or region. Standard warranty service response time is subject to change due to local parts availability. If so, your MTTs authorized service provider can provide you with details. MTTs will not alter form, fit, or function of this MTTs product to make it operate in a country for which it was never intended to function for legal or regulatory reasons. MTTs is not responsible for any tariffs or duties that may be incurred in transferring the products.

MTTS guarantees that the product that you have purchased or leased from MTTs is free from defects in materials or workmanship under normal use during Limited Warranty Period. The Limited Warranty Period starts on the date of purchase or lease from MTTs, or from the date MTTs completes installation. Your dated sales or delivery receipt, showing the date of purchase of the product, is your proof of the purchase or lease date. You may be required to provide proof of purchase or lease as a condition of receiving warranty service. You are entitled to hardware warranty service according to the terms and conditions of this document if a repair to your MTTs product is required within the Limited Warranty Period.

Unless otherwise stated, and to the extent permitted by local law, new MTTs product may be manufactured using new materials and used materials equivalent to new in performance and reliability. MTTs may repair or replace MTTs products (a) with new or previously used products or parts equivalent to new in performance and reliability, or (b) with equivalent products to an original product that has been discontinued. Replacement parts are warranted to be free from defects in material or workmanship for ninety (90) days or, for the remainder of Limited Warranty Period of the MTTs product they are replacing or in which they are installed, whichever is longer.

Warranty Policy

MTTS will, at its sole discretion, repair or replace any components or product that manifests a defect in materials or workmanship during the Limited Warranty Period. All component parts removed under this Limited Warranty become the property of MTTs. In the unlikely event that your MTTs product has recurring failures, MTTs at its sole discretion, may elect to provide you with (a) a replacement unit selected by MTTs that is the same or equivalent to your MTTs product in performance or (b) to give you a refund of your purchase price or lease payments (less interests) instead of a replacement. This is your exclusive remedy for defective products.

Exclusions

MTTS DOES NOT WARRANT THAT THE OPERATION OF THIS PRODUCT WILL BE UNINTERRUPTED OR ERROR-FREE. MTTS IS NOT RESPONSIBLE FOR DAMAGE THAT OCCURS AS RESULT OF YOUR FAILURE TO FOLLOW THE INSTRUCTIONS INTENDED FOR THE PRODUCT.

This Limited Warranty does not apply to expendable or consumable parts and does not extend to any product from which the serial number has been removed or that has been damaged or rendered defective (a) as a result of accident, misuse, abuse, contamination, improper or inadequate maintenance or calibration (if required) or other external causes; (b) by operation outside the usage parameters stated in the user documentation shipped with the product; (c) by software, interfacing, parts or supplies not supplied by MTTs; (d) improper site preparation or maintenance; (e) virus infection; (f) loss or damage in transit ; or (g) by modification or service by anyone other than (i) MTTs personnel, (ii) an MTTs authorized service provider, or (iii) your own installation of end-user replaceable MTTs or MTTs approved parts if available for your MTTs product in the servicing country or region.

Limitation of Liability

IF YOUR MTTs PRODUCT FAILS TO WORK AS WARRANTED ABOVE, THE MAXIMUM LIABILITY OF MTTs UNDER THIS LIMITED WARRANTY IS EXPRESSLY LIMITED TO THE LESSER OF THE PRICE YOU HAVE PAID FOR THE PRODUCT OR THE COSTS OF REPAIR OR REPLACEMENT OF ANY HARDWARE COMPONENTS THAT MALFUNCTION IN CONDITIONS OF NORMAL USE.

EXCEPT AS INDICATED ABOVE, IN NO EVENT WILL MTTs BE LIABLE FOR ANY DAMAGES CAUSED BY THE PRODUCT OR THE FAILURE OF THE PRODUCT TO PERFORM, INCLUDING ANY LOST PROFITS OR SAVINGS OR SPECIAL, INCIDENTAL, OR CONSEQUENTIAL DAMAGES. MTTs IS NOT LIABLE FOR ANY CLAIM MADE BY A THIRD PARTY OR MADE BY YOU FOR A THIRD PARTY.

THIS LIMITATION OF LIABILITY APPLIES WHETHER DAMAGES ARE SOUGHT, OR CLAIM MADE, UNDER THIS LIMITED WARRANTY OR AS A TORT CLAIM (INCLUDING NEGLIGENCE AND STRICT PRODUCT LIABILITY), A CONTRACT CLAIM, OR ANY OTHER CLAIM. THIS LIMITATION LIABILITY CANNOT BE WAIVED OR AMENDED BY ANY PERSON. THIS LIMITATION OF LIABILITY WILL BE EFFECTIVE EVEN IF YOU HAVE ADVISED MTTs OF THE POSSIBILITY OF ANY SUCH DAMAGES. THIS LIMITATION OF LIABILITY, HOWEVER, WILL NOT APPLY TO CLAIMS FOR PERSONAL INJURY.

THIS LIMITED WARRANTY GIVES YOU SPECIFIC LEGAL RIGHTS. YOU MAY ALSO HAVE OTHER RIGHTS THAT MAY VARY FROM COUNTRY TO COUNTRY. YOU ARE ADVISED TO CONSULT APPLICABLE COUNTRY LAWS FOR A FULL DETERMINATION OF YOUR RIGHTS.

Warranty Policy

Limited Warranty Period

The Limited Warranty Period for this MTTs product is a specified, fixed period commencing of the date of purchase and specified on the Warranty Card. The date on your sales receipt is the date of purchase unless MTTs or your reseller informs you otherwise in writing.

Customer Responsibilities

In order to avoid the risk of charges for issues not covered by your limited warranty (issues that are not due to defects in materials and workmanship on MTTs product), you will be asked to assist MTTs as follows:

Verify configurations, load most recent firmware, install software patches, run MTTs diagnostics and utilities;

Implement temporary procedures or workarounds provided by MTTs while MTTs works on permanent solution;

Cooperate with MTTs in attempting to resolve the problem using online chat, email, or telephone. This may involve performing routine diagnostic procedures, installing additional software updates or patches;

Perform additional tasks as defined within each type of warranty service provided by MTT and any other actions that MTTs may reasonably request in order to best perform the warranty support

CUSTOMER IS RESPONSIBLE FOR DELIVERING THE PRODUCT (AND ALL COSTS INVOLVED) FROM HIS LOCATION TO THE MTTs AUTHORIZED SERVICE POINT.

Contacting MTTs

If your MTTs product fails during the Limited Warranty Period and the suggestions in the product documentation do not solve the problem, you can receive support by doing one of the following:

- Locate and contact your nearest MTTs service provider via MTTs website:
<http://www.mttts-asia.com/support/>
- Call the Technical Support Center:
+84 43 766 6521

Before calling MTTs or an MTTs authorized service provider please have the following information available:

- Product serial number and model name
- Applicable error messages
- Detailed questions



MEDICAL TECHNOLOGY TRANSFER AND SERVICES Co., LTD
House No. 26, Alley 41, An Duong Vuong Street, Tay Ho District, Hanoi City, Vietnam



Tel: +84 24 3766 6521
Fax: +84 24 3718 8050
Email: assistance@mtts-asia.com
www.mtts-asia.com

EC REP

Logic s.r.l.
Via Antonio Pigafetta 1
34147 Trieste, Italy